

















Model : CF 9260-C (5'6")

Assembly Instruction

| | | | |
|---|---|---|-------|
| A |  | Headboard | 1pc |
| B |  | Footboard | 1pc |
| C |  | Side Rail | 4pcs |
| D |  | Footboard Legs No.99 - 60 x 150(H) No.127 - 30 x 80 x 240mm | 4pcs |
| E |  | Side Rail Legs No.127 | 2pcs |
| F |  | Center Rail 870mm | 2pcs |
| G |  | 14 pcs slat 1597mm | 2pcs |
| H |  | Support Legs 215mm | 4pcs |
| I |  | JCBB M8 x 20 | 8pcs |
| J |  | JCBC M6 x 30 | 8pcs |
| K |  | JCBC M6 x 60 | 4pcs |
| L |  | Allen Key 65mm | 1pc |
| M |  | Allen Key 70mm | 1pc |
| N |  | CSK Screw 32mm | 28pcs |
| O |  | Flat Washers | 8pcs |
| P |  | Small Adjuster | 4pcs |

Step 1 : Unzip the black non-woven fabric on the back of headboard and take out all the parts out.

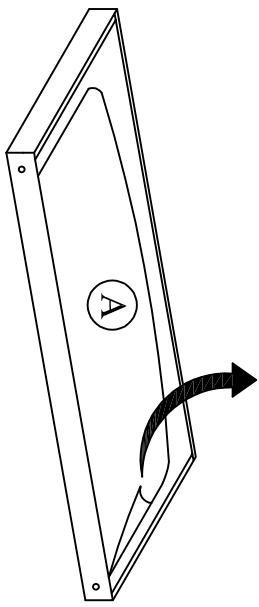

Attention: Zip the black non-woven fabric after take out the parts !!

BACK VIEW

Step 2 : Fix the footboard (B) with legs (D) as shown.

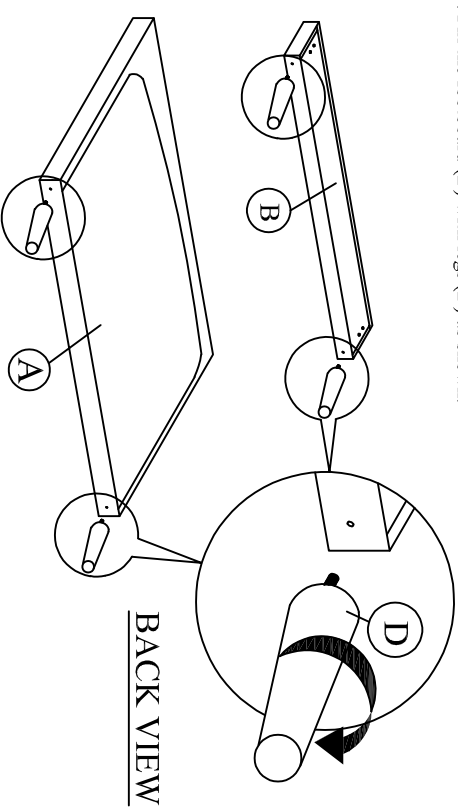

BACK VIEW

Step 3 : Attach the JCBB Bolt (I) to the headboard (A) and footboard (B).

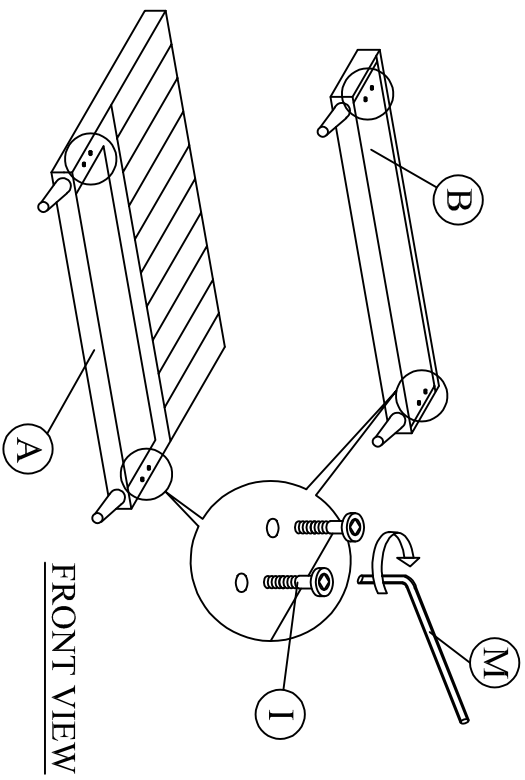

FRONT VIEW

Step 4 : Attach the side rail leg (E) to the side rail (C).

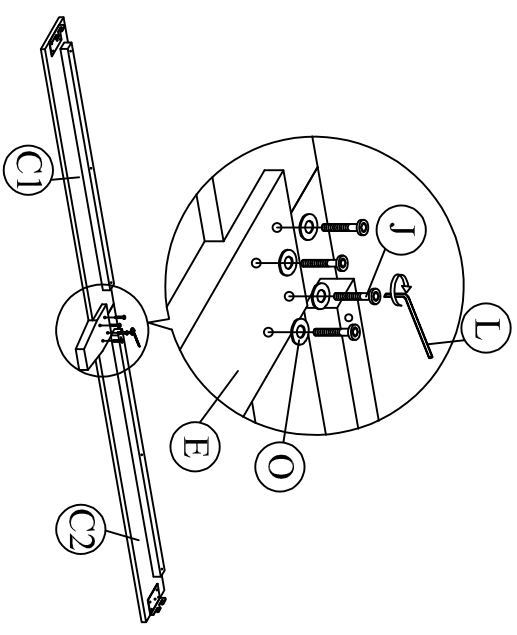

Step 5 : Attach side rail (C) to headboard (A) and footboard (B) by pushing the bracket down to fit it.

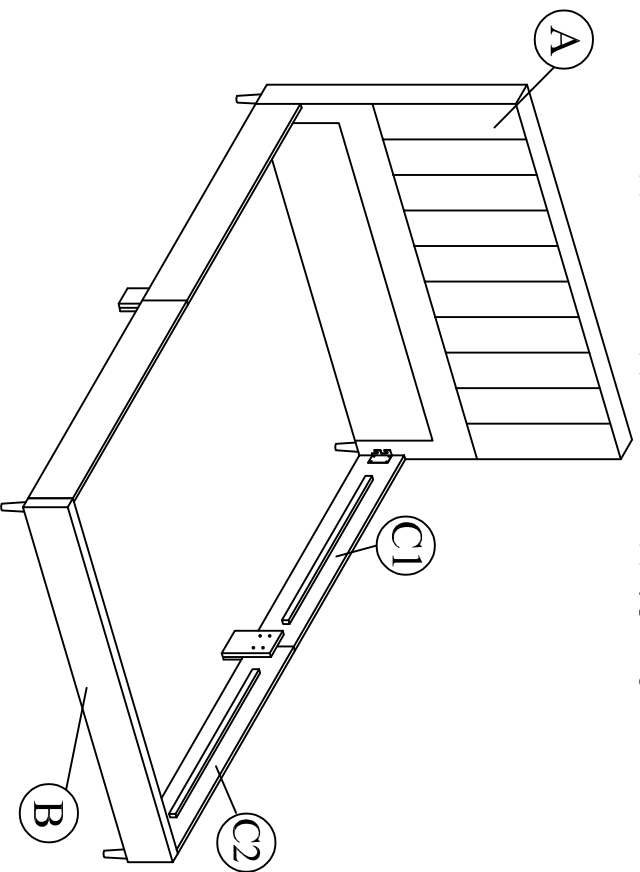

Step 6 : Attach the support legs (H) to the slats (G) and center rail (F).

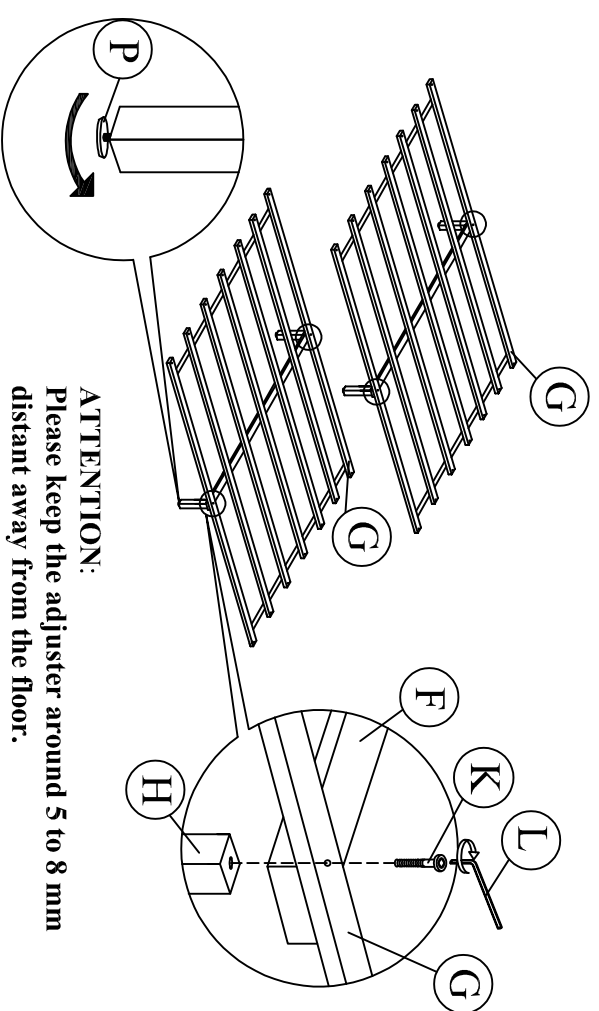

Step 7 : Tighten the 4 Corner with Allen Key (M). Install the bed slats to side rail. Tighten the slats with CSK screw. The distance of the slats should be sufficient to obtain desirable bed stability.

